



FORTIN®

KEY-OVERRIDE-ALL

SELF LEARNING ENCRYPTED TRANSPONDER BYPASS MODULE MODULE DE CONTOURNEMENT DE TRANSPONDEUR ENCRYPTÉ

THIS MANUAL IS SUBJECT TO CHANGE WITHOUT NOTICE
CE MANUEL PEUT FAIRE L'OBJET DE CHANGEMENTS SANS PRÉAVIS

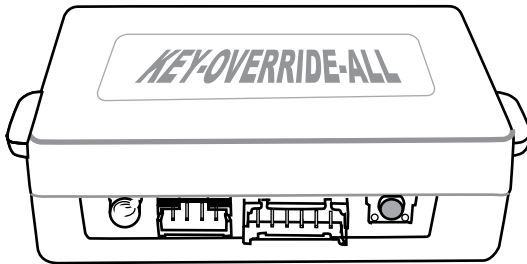

Module label | Étiquette sur le module

Notice: Updated Firmware and Installation Guides

Updated firmware and installation guides are posted on our web site on a regular basis. We recommend that you update this module to the latest firmware and download the latest installation guide(s) prior to the installation of this product.

Des mises à jour du Firmware (microprogramme) et des guides d'installation sont mis en ligne régulièrement. Vérifiez que vous avez bien la dernière version logiciel et le dernier guide d'installation avant l'installation de ce produit.



TECHNICAL SUPPORT
Tél: 514-255-HELP (4357)
1-877-336-7797



INSTALLATION GUIDE
Rev.20191010

www.fortinbypass.com

WEB UPDATE | MISE À JOUR INTERNET



Copyright © 2009-2011
FORTIN AUTO RADIO INC
ALL RIGHTS RESERVED

WIRE LEGEND | LEGENDE

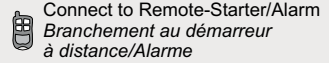
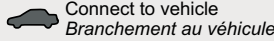
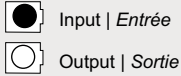

DESCRIPTION

See connection | Voir connexions

Make the connections and programming associated with the vehicle in the VEHICLE FITGUIDE (Page 4-6).
Déterminez le type de branchement et de programmation selon le GUIDE DES VÉHICULES (Page 4-6).

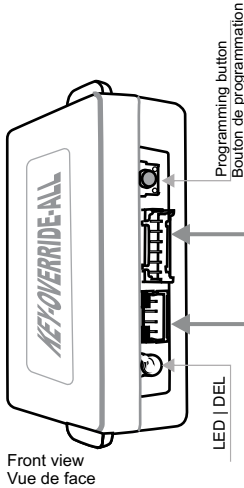

6-PIN CONNECTOR: MAIN CONNECTOR | CONNECTEUR PRINCIPALE (White | Blanc)

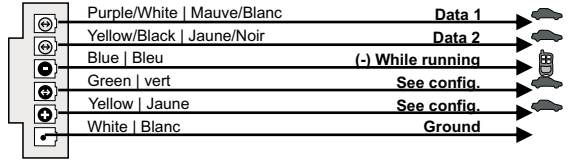

4-PIN CONNECTOR: DATA-LINK (Black | Noir) SEE PAGE 3 | VOIR PAGE 3

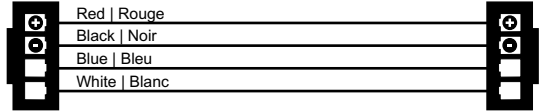

4-PIN CONNECTOR: RELAY | RELAIS (White | Blanc)

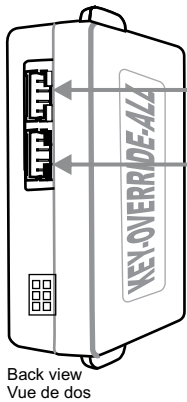
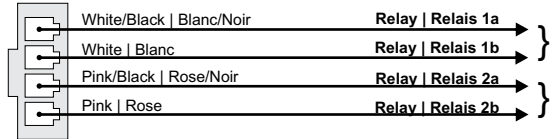

4-PIN CONNECTOR: Data-Link & Internet Firmware Update Connector* Data-Link & Connecteur pour mise à jour par internet* (White | Blanc)

Connect with the FLASH-LINK UPDATER to update the firmware by Internet.
Connectez avec le FLASH LINK UPDATER pour les mises à jour du module par internet.

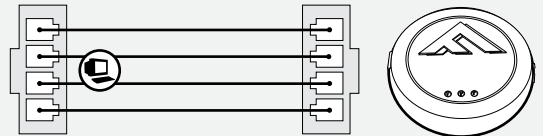

* Connector not supplied
* Connecteur non fournis

FLASH LINK UPDATER
Sold separately
Vendu séparément

LED DIAGNOSTIC

DIAGNOSTIQUES DES DELs

LED OFF: Not activated
DEL Éteint: Le module n'est pas activé

LED ON: Activated
DEL Allumé: Le module est activé

LED Flash: Not programmed.
DEL Flash: Le module n'est pas programmé.

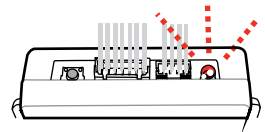
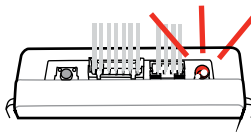
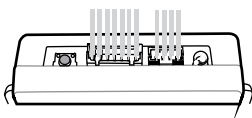

INSTALLATION PROCEDURE

1

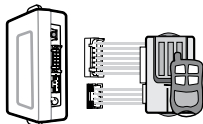

Determine if the remote-starter or alarm system supports 2-way Data-Link.

Déterminez si le démarreur à distance ou système d'alarme est compatible en Data-Link 2-voies.

WITH DATA-LINK AVEC DATA-LINK

In order to utilize this type of connection the remote-starter or alarm-system must be compatible with the **Fortin Data-link protocol**. Consult the installation guide or visit www.fortinbypass.com/datalink/ for more information.

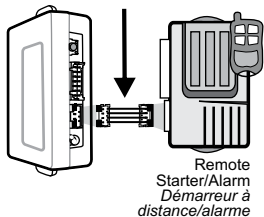

Le démarreur à distance ou le système d'alarme doit être compatible avec le **protocole Data-link Fortin** pour ces branchements. Consultez le guide d'installation du démarreur à distance ou du système d'alarme ou visitez le www.fortinbypass.com/datalink/ pour plus d'informations.

WITH OUT DATA-LINK SANS DATA-LINK

For all other remote-starters or alarm-systems perform the following connections.

Pour tout autres types de démarreurs à distance ou d'alarme, effectuez les branchements suivants.

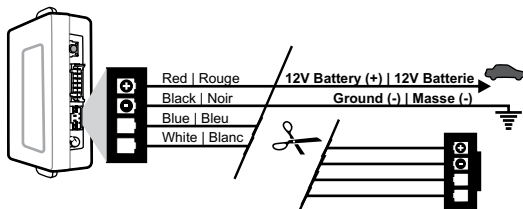

1 Cut off one plug of the 4 Pin Data-Link connector

2 Connect the Red wire to +12V

3 Connect the Black wire to Ground

1 Coupez l'extrémité du connecteur 4 pins Data-Link

2 Connectez le fil rouge au 12V

3 Connectez le fil noir à la masse du véhicule.

2

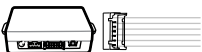

Make the connections:

Faire les branchements:



6-pin Connector (White):

Make the connections associated with the vehicle from the VEHICLE FIT GUIDE.

6-pins Connecteur (Blanc):

Effectuez les branchements associés au véhicule dans le GUIDE DES VÉHICULES.

4 PIN CONN.



4-pin Connector RELAY (White):

Make the connections (if required)

5-pins Connecteur RELAIS (Blanc):

Effectuez les branchements.(Si nécessaire)

3



PROGRAMMING PROCEDURE

PROCÉDURE DE PROGRAMMATION

Determine the programming procedure required for the vehicle in the VEHICLE FIT GUIDE.

Déterminez le type de programmation selon votre véhicule dans le GUIDE DES VÉHICULES.

Connection number
Numéro de connexion

Vehicle(s) associated with the procedure
Véhicule(s) associé(s) à la configuration

Programming number
Numéro de programmation

CONNECTION #

VEHICLE MAKE MODEL YEAR

PROGRAM: #

VEHICLE FIT GUIDE | GUIDE DES VÉHICULES

VEHICLE VÉHICULES	YEARS ANNÉES	Connection # (Page X)	Programming # (Page X)
ACURA			
CL	1997-1999	7 (P.10)	5A (P.18)
	2001-2003	7 (P.10)	5A (P.18)
CSX	2006-2011	8 (P.10)	5A (P.18)
EL	1998-2000	7 (P.10)	5A (P.18)
	2001-2005	6 (P.10)	5A (P.18)
Integra	2000-2001	7 (P.10)	5A (P.18)
MDX	2001-2002	7 (P.10)	5A (P.18)
	2003-2006	6 (P.10)	5A (P.18)
RDX	2007-2013	8 (P.10)	5A (P.18)
	2007-2012	8 (P.10)	5A (P.18)
RL	1998-2004	17 (P.13)	5D (P.18)
RSX	2005-2012	18 (P.13)	5A (P.18)
	2002-2006	6 (P.10)	5A (P.18)
TL	1998-2003	7 (P.10)	5A (P.18)
	2004-2014	6 (P.10)	5A (P.18)
TSX	2004-2008	6 (P.10)	5A (P.18)
	2009-2013	9 (P.11)	5A (P.18)
CHEVROLET			
Aveo	2004-2006 2008	10 (P.11)	5B (P.18)
Epica	2004-2007	11 (P.11)	5B (P.18)
Venture	1998-1999	2 (P.7)	5E (P.18)
FORD			
Contour	1998-2000	1C (P.7)	1 (P.15)
Crown Victoria	1997-2002	1H (P.7)	1 (P.15)
	2003-2004	1B (P.7)	2 (P.16)
	2005-2011	1A (P.7)	2 (P.16)
Econoline - E Series	2008-2014	1B (P.7)	2 (P.16)
Edge	2007-2010	1A (P.7)	2 (P.16)
Escape	2001-2007	1C (P.7)	2 (P.16)
	2008-2012	1A (P.7)	2 (P.16)
Escape Hybrid	2005-2007	1C (P.7)	2 (P.16)
	2008-2011	1A (P.7)	2 (P.16)
Excursion	2000-2002	1H (P.7)	1 (P.15)
	2003	1A (P.7)	2 (P.16)
	2004-2005	1A (P.7)	2 (P.16)
Expedition	1997-2001	1H (P.7)	1 (P.15)
	2002	1A (P.7)	2 (P.16)
	2003-2006	1C (P.7)	2 (P.16)
	2007-2014	1A (P.7)	2 (P.16)
Explorer	1998-2000	1H (P.7)	1 (P.15)
	2001	1C (P.7)	2 (P.16)
	2002-2005	1C (P.7)	2 (P.16)
	2006-2010	1A (P.7)	2 (P.16)
Explorer Sport Trac	2001	1B (P.7)	2 (P.16)
	2002-2005	1A (P.7)	2 (P.16)
	2006-2010	1A (P.7)	2 (P.16)
Fiesta	2011-2013	1A (P.7)	2 (P.16)
F150	1999-2002	1H (P.7)	1 (P.15)
	2003	1B (P.7)	1 (P.15)
	2004-2008	1C (P.7)	2 (P.16)
	2009-2010	1A (P.7)	2 (P.16)
F250 / F350 / F450	2007-2010	1A (P.7)	2 (P.16)
Five Hundred	2005-2007	1A (P.7)	2 (P.16)
Flex	2009-2013	1A (P.7)	2 (P.16)
Focus	2000-2007	1C (P.7)	2 (P.16)
	2008-2011	1A (P.7)	2 (P.16)
Freestar	2004-2007	1B (P.7)	2 (P.16)

VEHICLE VÉHICULES	YEARS ANNÉES	Connection # (Page X)	Programming # (Page X)
Freestyle	2005-2007	1A (P.7)	2 (P.16)
Fusion	2006-2012	1A (P.7)	2 (P.16)
GT	2005-2006	1A (P.7)	2 (P.16)
Mustang	1999-2002	1A (P.7)	1 (P.15)
	2003-2004	1A (P.7)	1 (P.15)
	2005-2014	1A (P.7)	2 (P.16)
Ranger	1999-2000	1B (P.7)	1 (P.15)
	2001-2006	1D (P.7)	2 (P.16)
	2007-2012	1B (P.7)	2 (P.16)
Taurus	1996-1999	1D (P.7)	1 (P.15)
	2000-2007	1B (P.7)	2 (P.16)
	2008-2010	1A (P.7)	2 (P.16)
Taurus X	2008-2009	1A (P.7)	2 (P.16)
Thunderbird	2002-2005	1C (P.7)	2 (P.16)
Transit Connect	2010-2014	1i (P.7)	2 (P.16)
Windstar	1999-2000	1B (P.7)	1 (P.15)
	2001-2003	1B (P.7)	2 (P.16)
HONDA			
Accord	1998-2002	7 (P.10)	5A (P.18)
	2003-2007	6 (P.10)	5A (P.18)
	2008-2012	9 (P.11)	5A (P.18)
Civic	2001-2005	6 (P.10)	5A (P.18)
	2006-2011	8 (P.10)	5A (P.18)
	2012-2013	9 (P.11)	5A (P.18)
CR-V	1998-2001	7 (P.10)	5A (P.18)
	2002-2006	6 (P.10)	5A (P.18)
	2007-2011	8 (P.10)	5A (P.18)
	2012-2013	9 (P.11)	5A (P.18)
	2011-2014	8 (P.10)	5A (P.18)
CR-Z Hybrid	2011-2014	8 (P.10)	5A (P.18)
Element	2003-2011	6 (P.10)	5A (P.18)
Fit	2006-2008	6 (P.10)	5A (P.18)
	2009-2014	8 (P.10)	5A (P.18)
Insight	2010-2014	8 (P.10)	5A (P.18)
	1998-2004	7 (P.10)	5A (P.18)
	2005-2010	6 (P.10)	5A (P.18)
Odyssey	2011-2014	9 (P.11)	5A (P.18)
	2003-2004	7 (P.10)	5A (P.18)
	2005-2008	6 (P.10)	5A (P.18)
Pilot	2009-2015	9 (P.11)	5A (P.18)
	2003-2004	7 (P.10)	5A (P.18)
	2005-2008	6 (P.10)	5A (P.18)
Prelude	1997-2001	17 (P.13)	5A (P.18)
Ridgeline	2006-2014	6 (P.10)	5A (P.18)
S2000	2000-2003	7 (P.10)	5A (P.18)
	2004-2009	6 (P.10)	5A (P.18)
HYUNDAI			
Tiburon 6 cyl.	2002-2008	13 (P.12)	5B (P.18)
Tucson	2004-2007	14 (P.12)	5B (P.18)
XG300	2001	12 (P.11)	5B (P.18)
XG350	2002-2005	12 (P.11)	5B (P.18)
INFINITI			
G20	2001-2002	15 (P.12)	5C (P.18)
I30	2001	15 (P.12)	5C (P.18)
I35	2002-2004	15 (P.12)	5C (P.18)
QX4	2001-2003	15 (P.12)	5C (P.18)
JAGUAR			
S-Type	2000-2007	1C (P.7)	2 (P.16)
X-Type	2002-2009	1C (P.7)	2 (P.16)
XJ8 / XJR	2004	1C (P.7)	2 (P.16)
KIA			
Sedona / Carnival	2004-2005	14 (P.12)	5B (P.18)

VEHICLE FIT GUIDE | GUIDE DES VÉHICULES

VEHICLE VEHICULES	YEARS ANNÉES	Connection # (Page X)	Programming # (Page X)
Sorento	2004-2006	14 (P.12)	5B (P.18)
Sportage	2005-2007	14 (P.12)	5B (P.18)
LEXUS			
ES 300	1998-2003	5 (P.9)	3 (P.17)
ES 330	2004-2006	4 (P.9)	3 (P.17)
Push-to-Start	2004-2006	3 (P.8)	4 (P.17)
ES 350	2007-2008	4 (P.9)	3 (P.17)
Push-to-Start	2007-2009	3 (P.8)	4 (P.17)
Push-to-Start	2009-2012	www : 1905	
GS 300	1998-2005	5 (P.9)	3 (P.17)
Push-to-Start	2006	3 (P.8)	4 (P.17)
GS 350	2007-2008	4 (P.9)	3 (P.17)
Push-to-Start	2007-2008	3 (P.8)	4 (P.17)
Push-to-Start	2009-2012	www : 3293	
GS 400	1997-2000	5 (P.9)	3 (P.17)
GS 430	2001-2005	5 (P.9)	3 (P.17)
Push-to-Start	2006-2007	4 (P.9)	3 (P.17)
Push-to-Start	2006-2007	3 (P.8)	4 (P.17)
GS 450H	2007-2008	4 (P.9)	3 (P.17)
Push-to-Start	2007-2011	3 (P.8)	4 (P.17)
GS 460	2008	4 (P.9)	3 (P.17)
Push-to-Start	2009-2011	www : 3293	
GX460	Push-to-Start 2010-2015	3 (P.8)	4 (P.17)
GX470	2003-2009	4 (P.9)	3 (P.17)
Push-to-Start	2007-2009	3 (P.8)	4 (P.17)
IS 250	2006-2008	4 (P.9)	3 (P.17)
Push-to-Start	2007-2008	3 (P.8)	4 (P.17)
Push-to-Start	2008-2013	www : 1806	
IS 300	2001-2005	5 (P.9)	3 (P.17)
IS 350	Push-to-Start 2006-2008	3 (P.8)	4 (P.17)
Push-to-Start	2009-2013	www : 1806	
LS 400	1997-2000	5 (P.9)	3 (P.17)
LS 430	2003-2006	4 (P.9)	3 (P.17)
Push-to-Start	2004-2006	3 (P.8)	4 (P.17)
LS 460	Push-to-Start 2007-2008	3 (P.8)	4 (P.17)
LS 600H	Push-to-Start 2008-2009	3 (P.8)	4 (P.17)
LX 470	1998-2002	5 (P.9)	3 (P.17)
Push-to-Start	2003-2007	4 (P.9)	3 (P.17)
Push-to-Start	2007	3 (P.8)	4 (P.17)
LX 570	Push-to-Start 2008	3 (P.8)	4 (P.17)
RX 300	1999-2003	5 (P.9)	3 (P.17)
RX 330	2004-2006	4 (P.9)	3 (P.17)
RX 350	2007-2008	4 (P.9)	3 (P.17)
Push-to-Start	2007-2008	3 (P.8)	4 (P.17)
Push-to-Start	2009-2015	www : 2006	
RX 400H	2006-2008	4 (P.9)	3 (P.17)
Push-to-Start	2006-2008	3 (P.8)	4 (P.17)
SC 300	1998-2000	5 (P.9)	3 (P.17)
SC 400	1998-2000	5 (P.9)	3 (P.17)
LINCOLN			
Aviator	2003-2005	1C (P.7)	2 (P.16)
Blackwood	2002-2003	1B (P.7)	1 (P.15)
Continental	1997-2002	1H (P.7)	1 (P.15)
LS	2000-2006	1C (P.7)	2 (P.16)
Mark LT	2006-2008	1C (P.7)	2 (P.16)
MKX	2007-2012	1A (P.7)	2 (P.16)
MKZ	2007-2012	1A (P.7)	2 (P.16)

VEHICLE VEHICULES	YEARS ANNÉES	Connection # (Page X)	Programming # (Page X)
Navigator	1998-2001	1H (P.7)	1 (P.15)
	2002	1B (P.7)	2 (P.16)
	2003-2006	1C (P.7)	2 (P.16)
	2007-2014	1A (P.7)	2 (P.16)
Town Car	1997-2002	1H (P.7)	1 (P.15)
	2003-2004	1A (P.7)	2 (P.16)
	2005-2011	1A (P.7)	2 (P.16)
Zephyr	2006	1A (P.7)	2 (P.16)
MAZDA			
2	2011-2014	1G (P.7)	2 (P.16)
3 / Axela	2004-2013	1F (P.7)	2 (P.16)
Smart Keyless	2010-2013	1F (P.7)	6 (P.19)
	2006-2014	1F (P.7)	2 (P.16)
5	2003-2008	1F (P.7)	2 (P.16)
6 / Atenza	2009-2013	1A (P.7)	2 (P.16)
	Smart Keyless 2009-2013	1E (P.7)	6 (P.19)
B-Series	1999-2001	1i (P.7)	1 (P.15)
	2002-2009	1B (P.7)	2 (P.16)
CX-7	2007-2012	1F (P.7)	2 (P.16)
CX-9	2007-2014	1F (P.7)	2 (P.16)
MPV	2000-2006	16 (P.13)	5D (P.18)
Miata	2002-2005	16 (P.13)	5D (P.18)
MX-5	2006-2014	1F (P.7)	2 (P.16)
RX-8	2003-2011	1F (P.7)	2 (P.16)
Tribute	2001-2011	1C (P.7)	2 (P.16)
MERCURY			
Cougar	1999-2002	1C (P.7)	1 (P.15)
Grand Marquis	1998-2002	1H (P.7)	1 (P.15)
	2003-2004	1B (P.7)	2 (P.16)
	2005-2010	1A (P.7)	2 (P.16)
Marauder	2003-2004	1B (P.7)	2 (P.16)
Mariner	2005-2007	1C (P.7)	2 (P.16)
	2008-2010	1A (P.7)	2 (P.16)
Mariner Hybrid	2005-2007	1C (P.7)	2 (P.16)
Milan	2008-2010	1A (P.7)	2 (P.16)
	2006	1B (P.7)	2 (P.16)
Montego	2007-2010	1A (P.7)	2 (P.16)
Monteoro	2005-2007	1B (P.7)	2 (P.16)
Monterey	2004-2007	1A (P.7)	2 (P.16)
Mountaineer	1998-2000	1H (P.7)	1 (P.15)
	2001	1B (P.7)	2 (P.16)
	2002-2005	1C (P.7)	2 (P.16)
Mystique	2006-2010	1A (P.7)	2 (P.16)
	1998-2000	1C (P.7)	1 (P.15)
Sable	1996-1999	1D (P.7)	1 (P.15)
	2000-2009	1A (P.7)	2 (P.16)
NISSAN			
Altima	2001-2004	15 (P.12)	5C (P.18)
Maxima	2001-2003	15 (P.12)	5C (P.18)
Pathfinder	2001-2004	15 (P.12)	5C (P.18)
Sentra	2001-2006	15 (P.12)	5C (P.18)
XTrail	2005-2007	15 (P.12)	5C (P.18)
OLDSMOBILE			
Silhouette	1998-1999	2 (P.7)	5E (P.18)
PONTIAC			
Grand Prix	2000-2001	2 (P.7)	5E (P.18)
Montana	2000-2001	2 (P.7)	5E (P.18)
Vibe	2008-2010	4 (P.9)	3 (P.17)

VEHICLE FIT GUIDE | GUIDE DES VÉHICULES

VEHICLE VÉHICULES	YEARS ANNÉES	Connection # (Page X)	Programming # (Page X)
Wave	2004-2006	10 (P.11)	5B (P.18)
	2008	10 (P.11)	5B (P.18)
SCION			
iQ	2012-2014	20 (P.14)	3 (P.17)
tC	2005-2010	4 (P.9)	3 (P.17)
	80-bit G-key 2010-2015	19 (P.14)	3 (P.17)
xB	2008-2010	4 (P.9)	3 (P.17)
	80-bit G-key 2010-2015	19 (P.14)	3 (P.17)
xD	2008-2010	4 (P.9)	3 (P.17)
	80-bit G-key 2010-2013	19 (P.14)	3 (P.17)
SUZUKI			
Swift	2005-2006	10 (P.11)	5B (P.18)
	2008		
Verona	2004-2006	11 (P.11)	5B (P.18)
TOYOTA			
4 Runner	1999-2002	5 (P.9)	3 (P.17)
	2003-2009	4 (P.9)	3 (P.17)
	80-bit G-key 2010-2014	19 (P.14)	3 (P.17)
	Push-to-Start 2010-2015	www : 2048	
Avalon	1998-2004	5 (P.9)	3 (P.17)
	2005-2012	4 (P.9)	3 (P.17)
	80-bit G-key 2010-2012	19 (P.14)	3 (P.17)
	Push-to-Start 2005-2012	3 (P.8)	4 (P.17)
Camry	1998-2004	5 (P.9)	3 (P.17)
	2003-2010	4 (P.9)	3 (P.17)
	Push-to-Start 2006-2008	3 (P.8)	4 (P.17)
	Push-to-Start 2009-2011	www : 1904	
	80-bit G-key 2009-2011	20 (P.14)	3 (P.17)
Hybrid Push-to-Start 2007-2011	3 (P.8)	4 (P.17)	
Corolla	2005-2010	4 (P.9)	3 (P.17)
	Push-to-Start 2009-2010	3 (P.8)	4 (P.17)
	80-bit G-key 2010-2013	19 (P.14)	3 (P.17)
	80-bit Push-to-Start 2011-2013	www : 3166	
FJ Cruiser	2007-2009	4 (P.9)	3 (P.17)
	80-bit G-key 2010-2014	20 (P.14)	3 (P.17)
Highlander - Kluger	2001-2003	5 (P.9)	3 (P.17)
	2004-2010	4 (P.9)	3 (P.17)
	80-bit G-key 2010-2013	19 (P.14)	3 (P.17)
	Push-to-Start 2008-2010	3 (P.8)	4 (P.17)
	Push-to-Start 2011-2012	www : 3600	
	Hybrid 2006-2013	4 (P.9)	3 (P.17)
Land Cruiser	1998-2002	5 (P.9)	3 (P.17)
	2003-2009	4 (P.9)	3 (P.17)
	2005-2010	4 (P.9)	3 (P.17)
Matrix	2010-2014	20 (P.14)	3 (P.17)
MR2 - Spyder	2003-2005	5 (P.9)	3 (P.17)
Prius Push-to-Start	2004-2011	www : 1503	
Rav4	2001-2003	5 (P.9)	3 (P.17)
	2004-2010	4 (P.9)	3 (P.17)
	80-bit G-key 2010-2012	19 (P.14)	3 (P.17)
Push-to-Start after 09/2009	2010-2012	www : 2316	
Sequoia	2005-2007	www : 3616	
	2008-2009	4 (P.9)	3 (P.17)
	80-bit G-key 2010-2014	www : 2487	
Sienna	1998-2003	5 (P.9)	3 (P.17)
	2004-2010	4 (P.9)	3 (P.17)
	80-bit G-key 2011-2014	20 (P.14)	3 (P.17)
	Push-to-Start 2011-2014	www : 2116	

VEHICLE VÉHICULES	YEARS ANNÉES	Connection # (Page X)	Programming # (Page X)
Solara	1999-2003	5 (P.9)	3 (P.17)
	2004-2008	4 (P.9)	3 (P.17)
	Push-to-Start 2007-2009	3 (P.8)	4 (P.17)
Tacoma	2005-2010	4 (P.9)	3 (P.17)
	80-bit G-key 2010-2015	19 (P.14)	3 (P.17)
Tundra	2007-2010	4 (P.9)	3 (P.17)
	80-bit G-key 2010-2015	20 (P.14)	3 (P.17)
Venza	2009-2010	4 (P.9)	3 (P.17)
	80-bit G-key 2009-2013	19 (P.14)	3 (P.17)
	Push-to-Start 2009-2015	www : 3311	
Yaris	2006-2010	4 (P.9)	3 (P.17)
	80-bit G-key 2010-2011	19 (P.14)	3 (P.17)
	Sedan 2012-2014	4 (P.9)	3 (P.17)

LEGEND | LÉGENDE

www - Visit www.fortinbypass.com to download an installation guide for this specific vehicle. | Visitez le www.fortinbypass.com pour télécharger un guide d'installation spécifique à ce véhicule.

CONNECTION

CONNECTION 1 FORD / MAZDA / JAGUAR / LINCOLN / MERCURY **GO PROGRAM: 1**
or GO PROGRAM: 2
Push to Start GO PROGRAM: 6

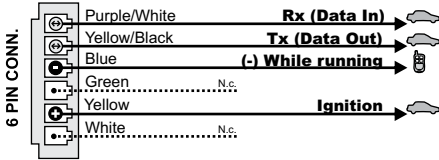

Ignition barrel
Barillet de l'ignition

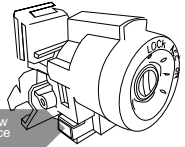

Back view
 Back Face

IGNITION BARREL CONNECTOR | CONNECTEURS AU BARILLET D'IGNITION

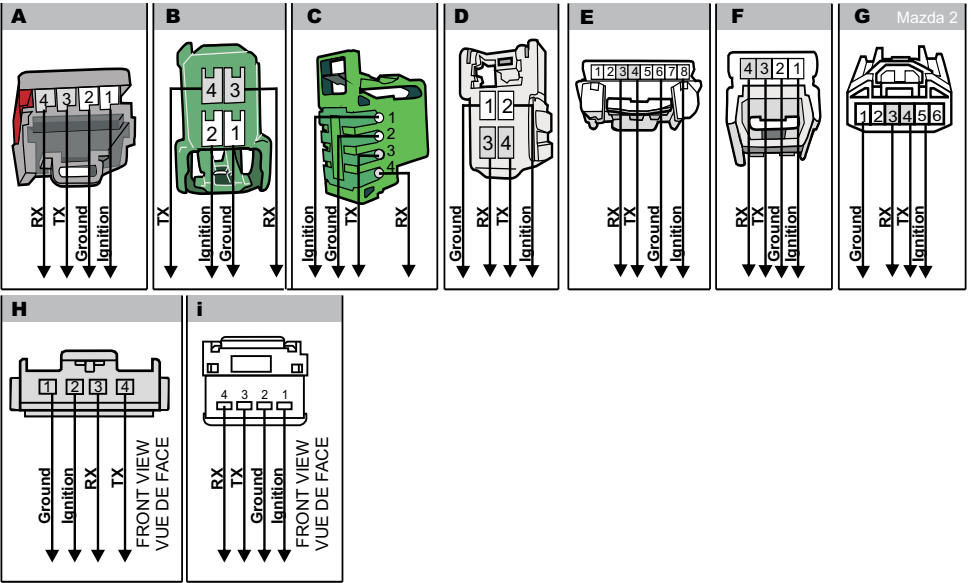

CONNECTION 2 CHEVROLET / OLDSMOBILE / PONTIAC **GO PROGRAM: 5E**

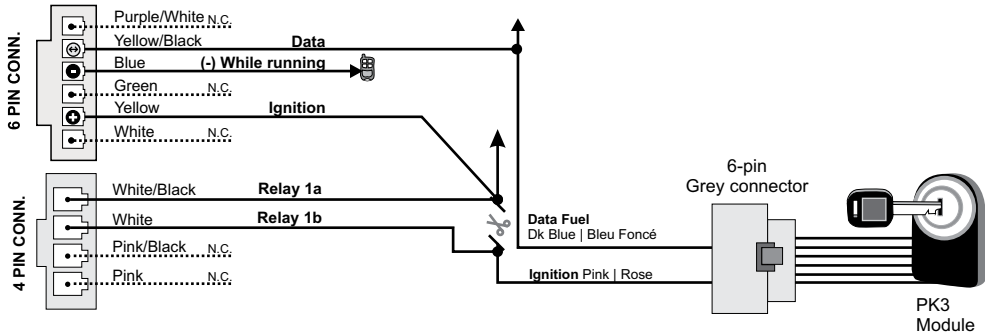

Input | Entrée
 Output | Sortie

Connect to vehicle
 Branchement au véhicule

Connect to Remote-Starter/Alarm
 Branchement au démarreur à distance/Alarme

CONNECTION 3 SUGGESTED INSTALLATION : TOYOTA / LEXUS SMART KEY **GO PROGRAM: 4**

Firmware version 2.01+ required | Version logicielle 2.01+ requise

Components required | Composantes requises:

2x Diodes 1 Amp | Diodes 1Amp
 2x 5 Amp fuse | Fusibles 5 Amp
 1x Relay | Relais
 1x 1Kohms Resistor | Résistance 1Kohms



Push-to-start button:
 Back view
 Vue de dos

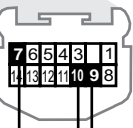

- Only if remote starter does not have (-) Starter out.
- Seulement si le démarreur n'a pas sortie Start neg.(-)

6 PIN CONN.

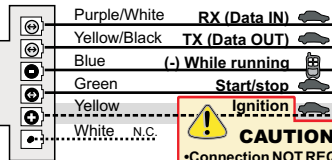
**CAUTION | ATTENTION**

- Connection NOT REQUIRED IN DATALINK MODE.
- Only connect the yellow wire after programming is complete.
- Branchement NON REQUIS EN MODE DATALINK.
- Branchez le fil jaune après avoir complété la programmation seulement.

4 PIN CONN.

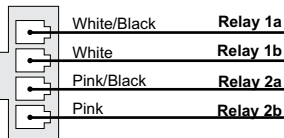

+12V

BRAKE SWITCH
 COMMUTEUR DE FREIN

Only connect at the brake switch.
 Branchez au commutateur de frein seulement.

5 Amp Fuse required
 Fusibles 5 Amp requise

BRAKE LIGHT
LUMIÈRE DE FREIN

The remote starter must be programmed in DIESEL mode (Wait to Start) in order to activate the foot-brake at least 5 seconds before remote-start.

Le démarreur doit être programmé en mode DIESEL (attendre avant démarrage) de façon à ce que la pédale de frein soit activée 5 secondes avant le démarrage à distance.

Once remote-started, the module will shut-down the engine when the GWR is removed. The module will delay the shut-down for 45 seconds if the doors are unlocked first. This allows the customer enough time to get in and shut down the remote-starter with the foot-brake normally.

Il est normal que les lumières de freins sont allumées avant le démarrage.
 Une fois le véhicule démarré à distance, le module commande l'arrêt du moteur lorsque la pédale de frein est retirée.
 Cette fonction peut être contournée en appuyant sur le bouton Déverrouillage de la télécommande du démarreur, le conducteur a alors 45 secondes pour entrer dans la voiture et peser sur la pédale de frein avant que le moteur ne s'arrête.
 Si le véhicule est démarré par démarrage à distance avec le SMARTKEY à l'intérieur du véhicule, le module ne commandera pas l'arrêt du moteur lorsque la masse d'activation est retirée.

If the SMART-KEY is in proximity when the vehicle is remote-started, the module will not shut down the engine when the GWR is removed.

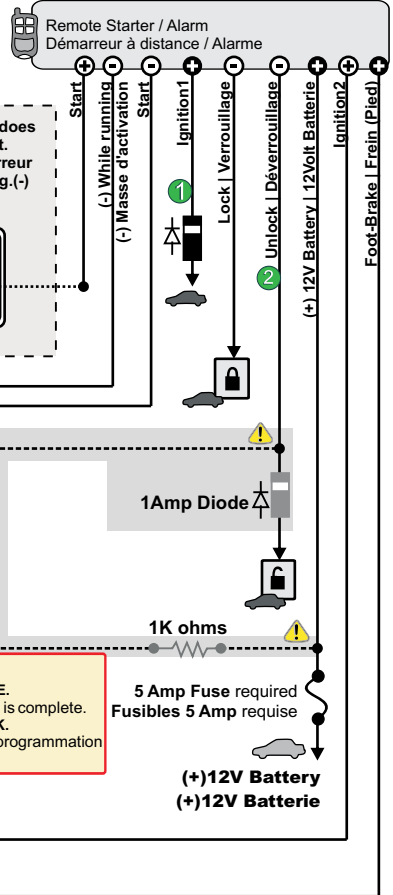

1 Connect to ignition(+) at the fuse box. | Connectez à Ignition(+) de la boîte à fusible.

2 Unlock must be connected because the doors can not be unlocked using the OEM remote once the vehicle is remote-started. Déverrouillage doit être branché car l'option car les portes ne peuvent pas se déverrouiller avec les télécommandes d'origine lorsque le moteur est en fonction.

CONNECTION 4

TOYOTA / LEXUS

GO PROGRAM: 3

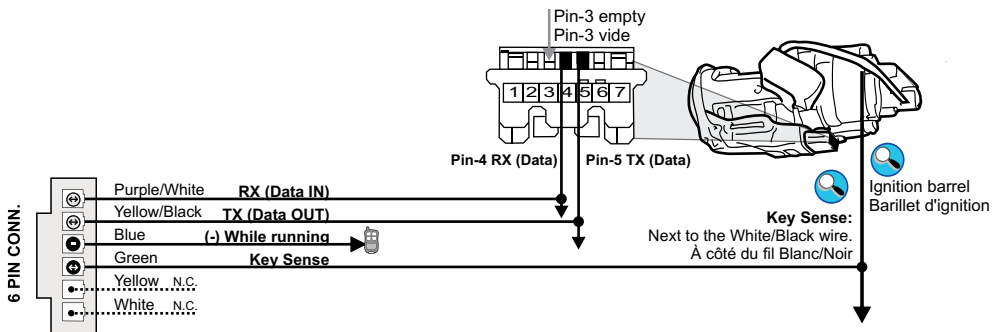

CONNECTION 5

TOYOTA / LEXUS

GO PROGRAM: 3

LEXUS	YEARS	CLK	DATA	Synchro	Key Sense	TOYOTA	YEARS	CLK	DATA	Synchro	Key Sense
ES 300	98-01	Red/Blue	Green/White	Blue/Yellow	Blue/Black	4Runner	99-02	Red/Black	Gray/Red	Pink/Black	Yellow/Red
	02-03	Red/Blue	Green/White	Blue/Yellow	Blue		Avalon	98-99	Yellow	Black/Red	Green
GS 300	98-05	Black/White	Green/Black	Blue/Red	Yellow	Camry	00-04	Blue/Orange	Pink/Green	Blue/Yellow	Red/White
GS 400	98-00	Black/White	Green/Black	Blue/Red	Yellow		96-00	Red/Blue	Green/White	Blue/Yellow	Blue/Black
GS 430	01-05	Black/White	Green/Black	Blue/Red	Yellow	02-04*	Red/Blue	Green/White	Blue/Yellow	Blue/Black	Blue/Black
	IS300	01	Purple	Green	Pink	Black/Yellow	02-04*	Red/Blue	Green/White	Blue/Yellow	Blue
LS 400	02-05	Purple	Green/Black	Pink/Black	Black/Yellow	Highlander	99-03	Pink	Gray/Blue	Gray	Blue
	98-00	Red/Black	Red/White	Red	Yellow		98-02	Purple/Green	Blue/Black	Red/Yellow	Red/Black
LX 470	98-02	Purple/Green	Blue/Black	Red/Yellow	Red/White	MR2 Spider	03-05	Yellow	Yellow/Green	Yellow/Black	Blue/Red
RX 300	99	Black	Purple	Gray	Blue	RAV4	01-03	Yellow	Yellow/Green	Yellow/Black	Blue/Red
	00-03	Pink	Purple	Gray	Blue	Sienna	99-03	Brown/Red	Brown/White	Brown/Yellow	Blue/Black
SC300	99-00	Blue	Black/Orange	Green/Orange/Yellow		Solara	99-03	Red/Blue	Green/White	Blue/Yellow	Blue/Black
SC400	99-00	Blue	Black/Orange	Green/Orange/Yellow							

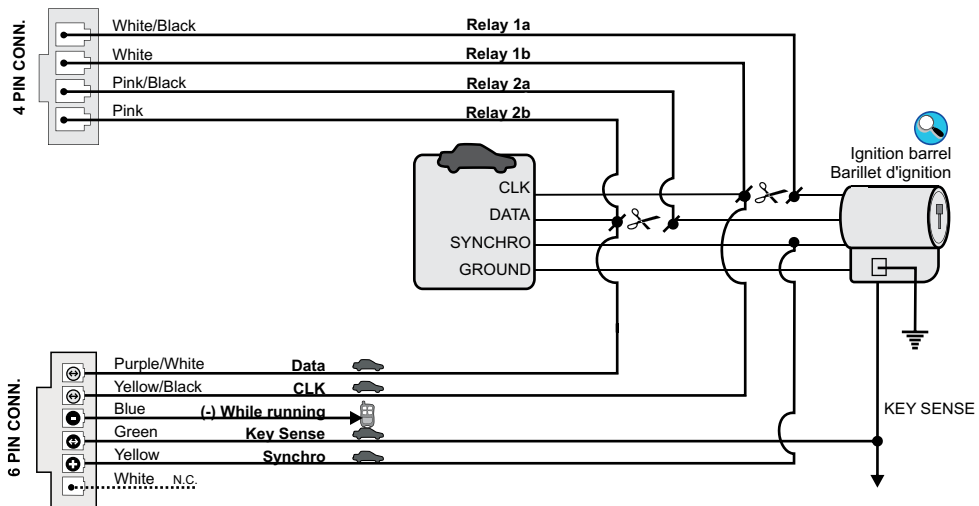

● Input | Entrée
○ Output | Sortie

Connect to vehicle
Branchement au véhicule

Connect to Remote-Starter/Alarm
Branchement au démarreur à distance/Alarme

CONNECTION 6 ACURA / HONDA **GO PROGRAM: 5A**

Honda	Data Pin 2	Security Light Pin 5	Ignition Pin 6	Acura	Data Pin 2	Security Light Pin 5	Ignition Pin 6
Accord	Red/Blue	Blue/Orange	Black/Yellow	1.7EL	Red/Blue	Blue/Orange	Yellow/Black
Civic	Red/Blue	Blue/Orange	Yellow/Black	MDX	Red	Pink	Green/White
CRV	White	Blue/Orange	Yellow/Black	RL	Lt. Green	Red	Pink
Element	White	Blue/Orange	Yellow/Black	RSX	Red/Blue	Blue/Orange	Yellow/Black
Fit	Light Green/Black	Red/Black	Yellow/Black	TL	Yellow	Orange	Black/Green
Odyssey	Red/Blue	Blue/Orange	Yellow/Black	TSX	Red/Blue	Blue/Orange	Yellow/Black
Pilot	Red/Green	White/Blue	Red/White				
Ridgeline	Red/Blue	Blue/Orange	Green/Black				
S-2000	Red/Blue	Pink	Black/Yellow				

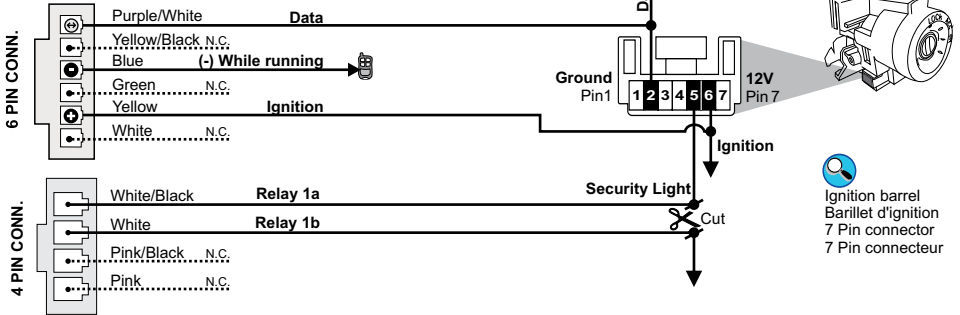

Ignition barrel
Barillet d'ignition
7 Pin connector
7 Pin connecteur

CONNECTION 7 ACURA / HONDA **GO PROGRAM: 5A**

Acura	Ignition Pin 1	Data Pin 2	Synchro Pin 3	Ground Pin 4	Honda	Ignition Pin 1	Data Pin 2	Synchro Pin 3	Ground Pin 4
1.6EL	Yellow/Black				Accord	Yellow/Black	Red	Blue	Brown/Black
CL	Yellow/Black	Red	Blue/White	Brown/Yellow	CRV	Yellow/Black	Red	Blue	Brown/Black
Integra	Yellow/Black	Red	Blue		Odyssey	Yellow/Black	Blue/Green	Orange/Blue	Brown/Black
MDX	Yellow/Black	Red	Blue	Brown/Black	Pilot	Yellow/Black	Red	Blue	Brown/Yellow
TL	Yellow/Black	Red	Blue	Brown/Yellow	S-2000	Yellow/Black	Red/Blue	Pink/Blue	

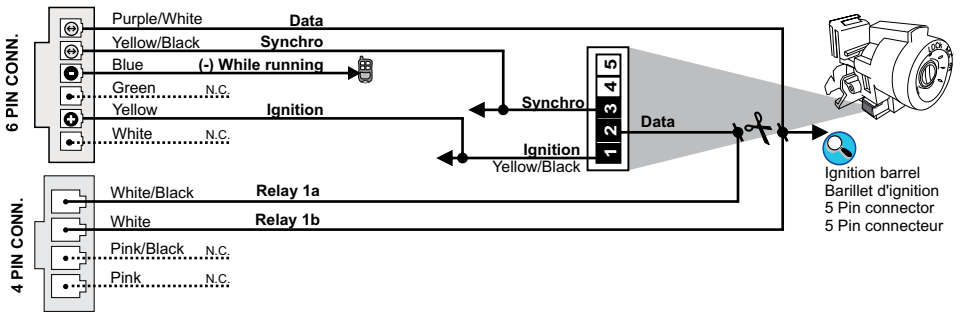

Ignition barrel
Barillet d'ignition
5 Pin connector
5 Pin connecteur

CONNECTION 8 ACURA / HONDA **GO PROGRAM: 5A**

Acura	Data Pin 3	Ignition Pin 2	Honda	Data Pin 3	Ignition Pin 2
CSX	Small Light Green	Yellow	Civic	Small Light Green	Yellow
MDX	Small Light Green	Brown	CR-V	Small Green	Blue
RDX	Small Light Green	Yellow	CR-Z	Pink	Brown
			Fit	Green	Red
			Insight	Green	Red

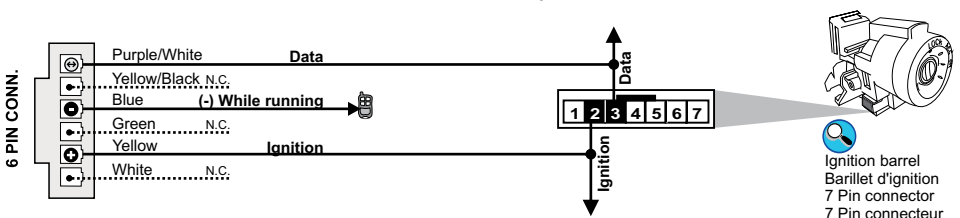

Ignition barrel
Barillet d'ignition
7 Pin connector
7 Pin connecteur

CONNECTION 9 ACURA / HONDA **GO PROGRAM: 5A**

HONDA CRV 2014: Firmware version 0.16 required | Version logicielle 0.16 requise

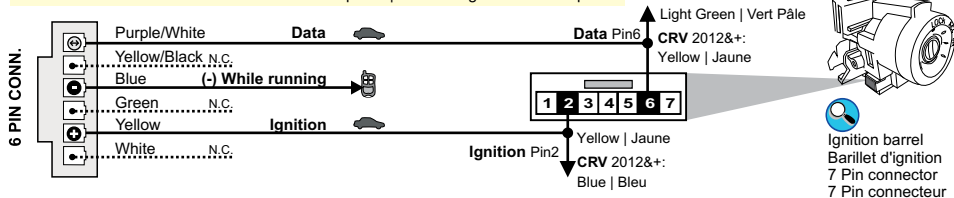

CONNECTION 10 CHEVROLET AVEO (SL) / PONTIAC WAVE / SUZUKI SWIFT **GO PROGRAM: 5B**

KEY-OVERRIDE-ALL V.3.0 & +

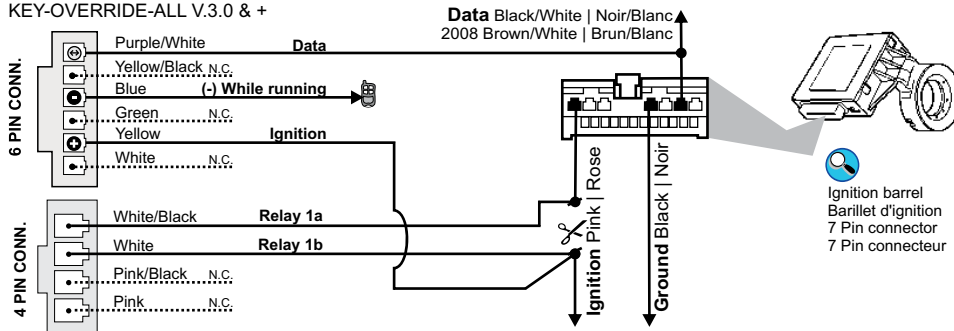

CONNECTION 11 CHEVROLET EPICA / SUZUKI VERONA **GO PROGRAM: 5B**

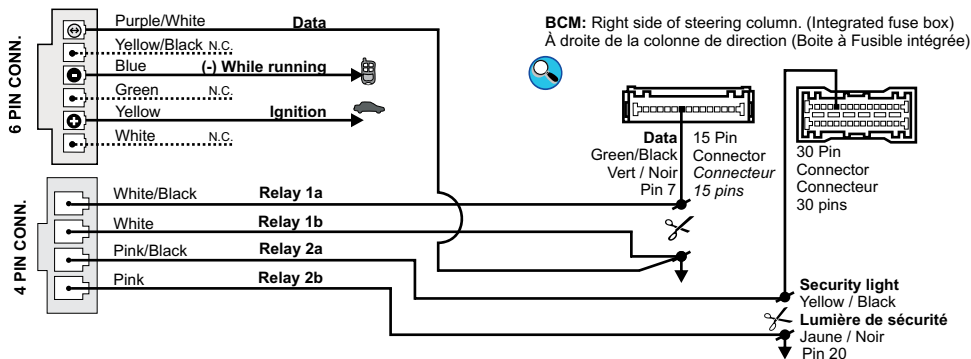

CONNECTION 12 HYUNDAI XG 300 / XH 350 **GO PROGRAM: 5B**

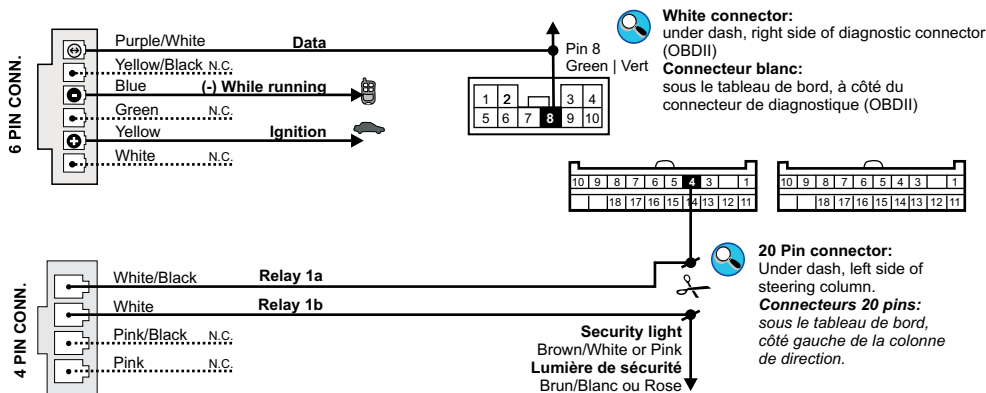

CONNECTION 13

HYUNDAI TIBURON V6

GO PROGRAM: 5B

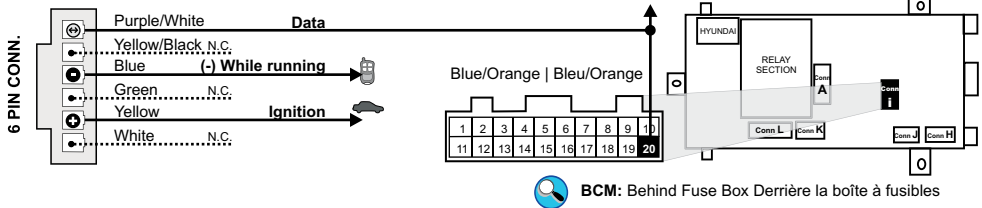

CONNECTION 14

KIA / HYUNDAI

GO PROGRAM: 5B

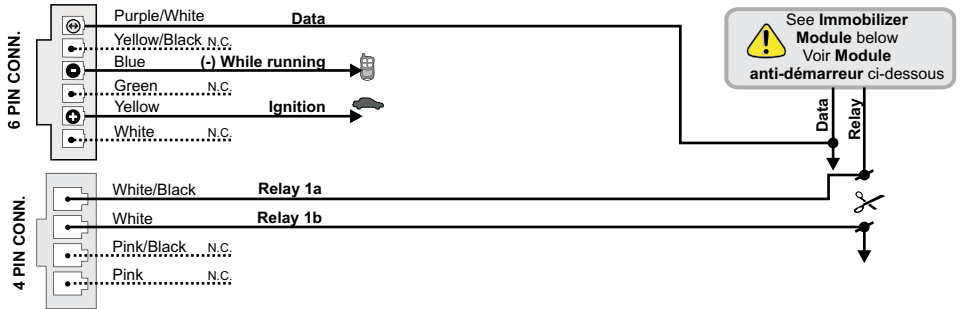

KIA

	DATA Pin 2	RELAY Pin 6
Sportage V6	Brown/Orange	White/Black
HYUNDAI		
Tucson V6	Brown/Orange	White/Black

8-pin connector

Immobilizer Module:
Left side of steering column.
Module anti-démarrreur:
À gauche de la colonne de direction.

KIA

	DATA Pin 7	RELAY Pin 2
Sedona 2004	Red	Green or Orange
Sorento	Blue	Blue/Orange

10-pin connector

Immobilizer Module:
Right side of steering column.
Module anti-démarrreur:
À droite de la colonne de direction.

KIA

	DATA Pin 8	RELAY Pin 3
Sedona 2005	Red	Orange (Security Light)

10-pin connector

Immobilizer Module:
Right side of steering column.
Module anti-démarrreur:
À droite de la colonne de direction.

CONNECTION 15

NISSAN / INFINITI

GO PROGRAM: 5C

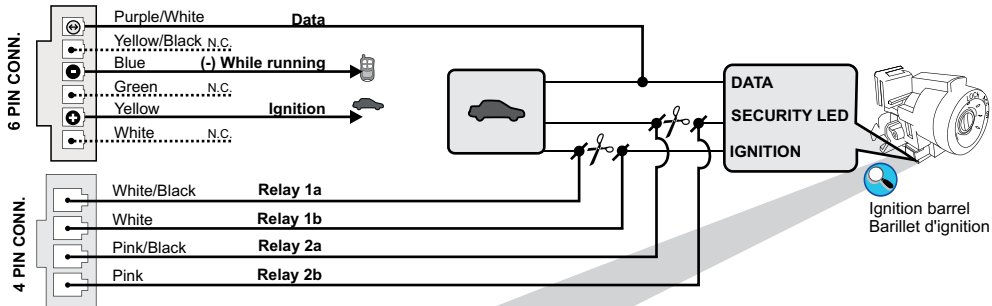

OR / OU

PIN #	DESCRIPTION
6	DATA
5	N.C.
4	GROUND
3	SECURITY LED
2	IGNITION
1	12V Battery

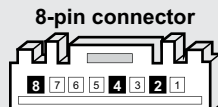
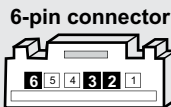

PIN #	DESCRIPTION
8	DATA
7	N.C.
6	N.C.
5	GROUND
4	SECURITY LED
3	N.C.
2	IGNITION
1	12V Battery

CONNECTION 16

MAZDA MIATA / MPV

GO PROGRAM: 5D

Firmware version 3.02+ required
Version logicielle 3.02+ requise

MAZDA	Data Pin 5	Ignition Pin 7
MPV 2000-2003	Blue/White	Black/White
MPV 2004-2006	Blue/White	Black/White
Miata 2001-2004	Red/Black	Black/White

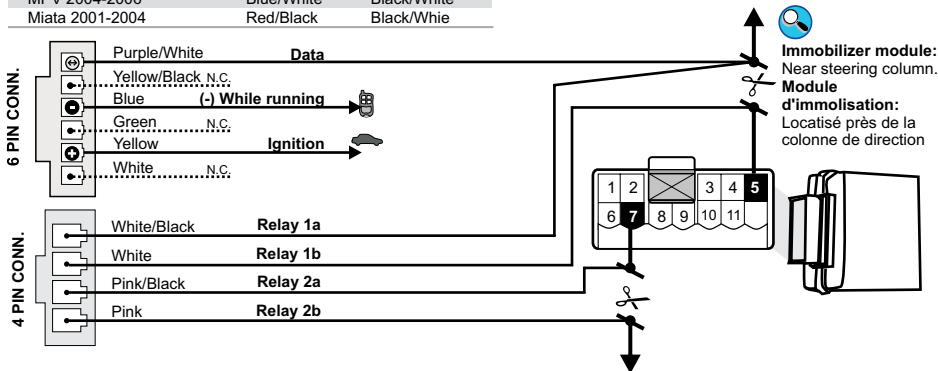

Immobilizer module:
Near steering column.
Module d'immobilisation:
Localisé près de la colonne de direction

CONNECTION 17

ACURA RL & HONDA PRELUDE

GO PROGRAM: 5A

ACURA YEARS	Data Pin 6	Ignition Pin 4	Start Enable Pin 3
RL 98-04	White	Yellow/Black	Pink

HONDA YEARS	Data Pin 6	Ignition Pin 4	Start Enable Pin 3
Prelude 97	Brown/Yellow	Black/Yellow	Lt Blue
98-01	Brown/Yellow	Yellow/Black	Lt Blue

Firmware version 3.03+ required
Version logicielle 3.03+ requise

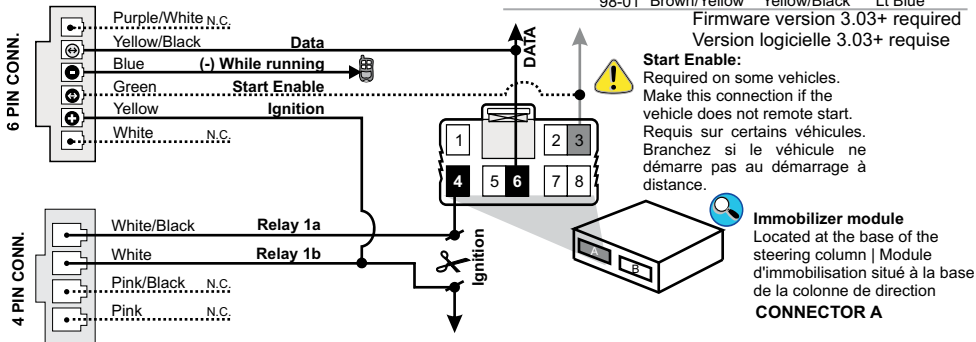

Start Enable:
Required on some vehicles.
Make this connection if the vehicle does not remote start.
Requis sur certains véhicules.
Branchez si le véhicule ne démarre pas au démarrage à distance.

Immobilizer module
Located at the base of the steering column | Module d'immobilisation situé à la base de la colonne de direction
CONNECTOR A

CONNECTION 18

ACURA RL 2005-2008

GO PROGRAM: 5A

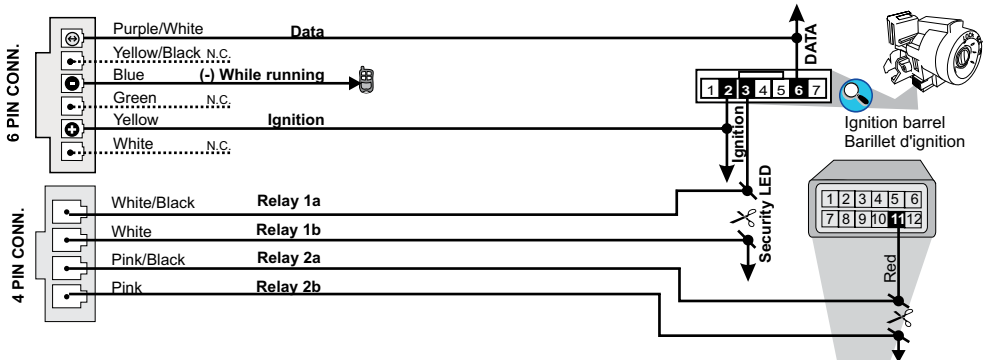

Ignition barrel
Barillet d'ignition

ACURA YEARS	Data Pin 2	Ignition Pin 6	Security Light Pin 5
RL 05-06	Lt Green or Orange	Pink	Blue or Red
07-10	Orange	Pink	Red

Keyless access indicator:
Indicateur d'accès sans clé:
Grey connector located behind the electric mirror switch at left of the steering wheel. | Connecteur épissure Gris situé derrière le commutateur de miroir élect. à gauche de la colonne de direction.

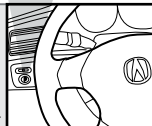

CONNECTION 19

TOYOTA / SCION G STAMPED KEY

GO PROGRAM: 3

Photos with each connectors location are available in the vehicle specific installation guides at www.fortinbypass.com.
Photos des connecteurs et des locations sont disponibles dans les guides individuels des véhicules sur www.fortinbypass.com



Back view | Vue de dos

Firmware version 4.00+ required
Version logicielle 4.00+ requise

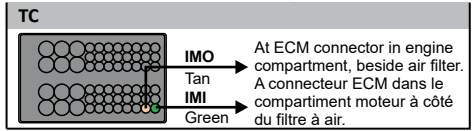
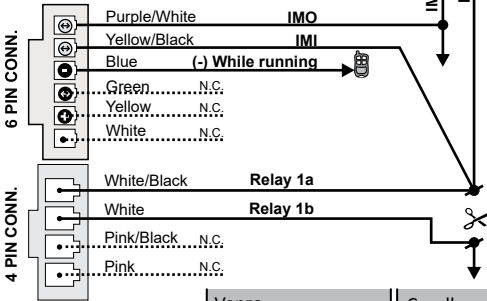

	IMI	IMO
4Runner	White Pin 14	Lt.Blue Pin 20
Highlander 4 cyl.	Light Blue Pin 31	Violet Pin 32
Highlander 6 cyl.	Lt.Blue Pin 14	Violet Pin 20
Tacoma 6cyl.	Blue/White Pin 14	Lt.Green/Black Pin 20

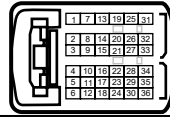

Behind glove box at ECM.
Derrière le coffre à gant à l'ECM.

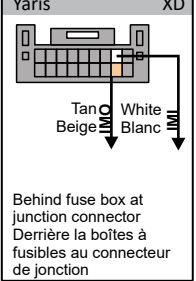
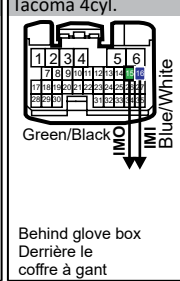
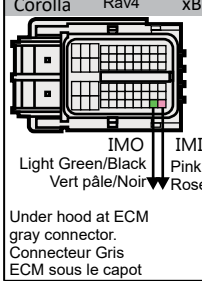
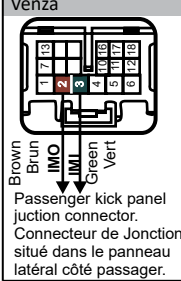
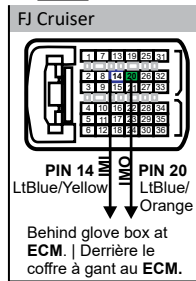

CONNECTION 20

TOYOTA G STAMPED KEY

GO PROGRAM: 3

Photos with each connectors location are available in the vehicle specific installation guides at www.fortinbypass.com.
Photos des connecteurs et des locations sont disponibles dans les guides individuels des véhicules sur www.fortinbypass.com

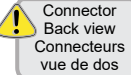

Back view | Vue de dos

Firmware version 4.00+ required
Version logicielle 4.00+ requise

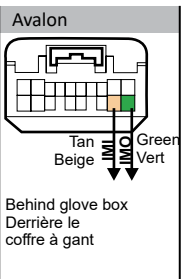
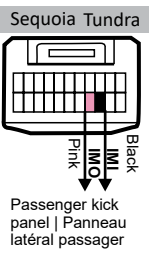
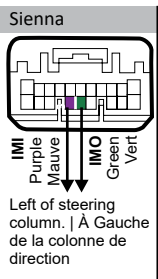
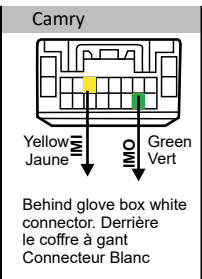
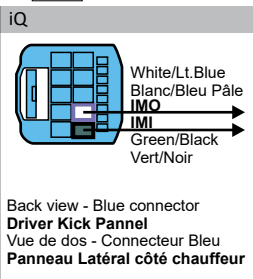
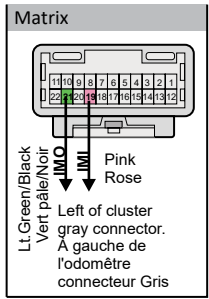
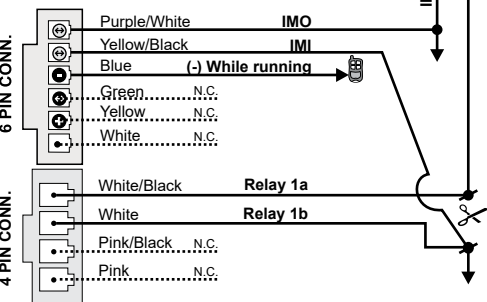

PROGRAM. 1

FORD / JAGUAR / MAZDA / LINCOLN / MERCURY

1 key required 1 clé requise

Vehicle equipped with SMART KEY
Véhicule équipé d'une clé INTELLIGENTE



Remove all keys from key remotes.
Retirez les clés des télécommandes.



Keep all cards at least 3 meters (10 feet) away from the vehicle.
Éloignez les télécommandes du véhicule (10 pieds / 3 mètres minimum).

1						
	Press and hold the programming button: Appuyez et maintenez enfoncé le bouton de programmation:	Insert connector 2. (6-pin) Insérez le connecteur 2 (6-pins).	Insert connector 3. (4-pin - if required) Insérez le connecteur 3 (4-pins - si requis).	Insert the 4-pin (Data-Link) connector. Insérez le connecteur 4-pins (Data-Link).	The RED LED will turn ON. La DEL ROUGE s'allumera.	Release the programming button. Relâchez le bouton de programmation.

2	⌚ 3 sec.	5 sec. max	⌚ 3 sec.	3	⌚ 3 sec.
Turn the first key to the ON/RUN position. Tournez la clé #1 à la position ON/RUN.	Wait 3 seconds or until the security light turns OFF. Attendre 3 secondes ou jusqu'à ce que la lumière sécurité du tableau de bord s'éteigne.	Turn the key to the OFF position and remove the first key. Tournez la clé à la position ARRÊT (OFF) et retirez la clé du barillet.	Wait 3 seconds. Attendre 3 secondes.	Turn the first key to the ON/RUN position. Tournez la clé #1 à la position ON/RUN.	Wait 3 seconds or until the security light turns OFF. Attendre 3 secondes ou jusqu'à ce que la lumière sécurité du tableau de bord s'éteigne.

5 sec. max	AUTOMATIC Transmission AUTOMATIQUE	5 sec. max	MANUAL Transmission MANUEL
Activate the remote starter. Actionnez le démarreur à distance.	The RED LED will flash ten (10x) times. La DEL ROUGE clignotera dix (10x) fois.	If the LED is solid RED disconnect the 4-pin connector (Data-Link) and go back to step 1. Si le DEL est Rouge solide débranchez le connecteur 4-pins (Data-Link) et retournez à l'étape 1.	The module is now programmed. Le module est programmé.

OR OU	5 sec. max	MANUAL Transmission MANUEL	5 sec. max	MANUAL Transmission MANUEL	5 sec. max
Turn the key to the OFF position and remove the key. Tournez la clé à la position ARRÊT (OFF) et retirez la clé du barillet.	Press and release the programming button. Pesez et relâchez le bouton de programmation.	Using a jumper wire, apply power (12v) to the vehicles ignition. À l'aide d'un fil (jumper) appliquez 12v sur l'ignition du véhicule.	The RED LED will flash ten (10x) times. La DEL ROUGE clignotera dix (10x) fois.	If the LED is solid RED disconnect the 4-pin connector (Data-Link) and go back to step 1. Si le DEL est Rouge solide débranchez le connecteur 4-pins (Data-Link) et retournez à l'étape 1.	Remove the jumper. The module is now programmed. Retirez le fil (jumper). Le module est programmé.

PROGRAM. 2

FORD / JAGUAR / MAZDA / LINCOLN / MERCURY

2 keys required 2 clés requises

Vehicle equipped with SMART KEY
Véhicule équipé d'une clé INTELLIGENTE

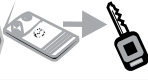

Remove all keys from key remotes.
Retirez les clés des télécommandes.



Keep all cards at least 3 meters (10 feet) away from the vehicle.
Éloignez les télécommandes du véhicule (10 pieds / 3 mètres minimum).

1						
	Press and hold the programming button: Appuyez et maintenez enfoncé le bouton de programmation:	Insert connector 2. (6-pin) Insérez le connecteur 2 (6 pins).	Insert connector 3. (4-pin - if required) Insérez le connecteur 3 (4-pins - si requis).	Insert the 4-pin (Data-Link) connector. Insérez le connecteur 4-pins (Data-Link).	The RED LED will turn ON. La DEL ROUGE s'allumera.	Release the programming button. Relâchez le bouton de programmation.

2	⌚ 3 sec.	5 sec. max	⌚ 3 sec.	3	⌚ 3 sec.
Turn the first key to the ON/RUN position. Tournez la clé #1 à la position ON/RUN.	Wait 3 seconds or until the security light turns OFF. Attendez 3 secondes ou jusqu'à ce que la lumière sécurité du tableau de bord s'éteigne.	Turn the key to the OFF position and remove the first key. Tournez la clé à la position ARRÊT (OFF) et retirez la clé du barillet.	Wait 3 seconds. Attendez 3 secondes.	Turn the second key to the ON/RUN position. Tournez la seconde clé à la position ON/RUN.	Wait 3 seconds or until the security light turns OFF. Attendez 3 secondes ou jusqu'à ce que la lumière sécurité du tableau de bord s'éteigne.





5 sec. max	AUTOMATIC Transmission AUTOMATIQUE		>>>
Activate the remote starter. Actionnez le démarreur à distance.	The RED LED will flash ten (10x) times. La DEL ROUGE clignotera dix (10x) fois.	If the LED is solid RED disconnect the 4-pin connector (Data-Link) and go back to step 1. Si le DEL est Rouge solide débranchez le connecteur 4-pins (Data-Link) et retournez à l'étape 1.	The module is now programmed. Le module est programmé.

OR	5 sec. max	MANUAL Transmission MANUEL		>>>
Turn the key to the OFF position and remove the key. Tournez la clé à la position ARRÊT (OFF) et retirez la clé du barillet.	Press and release the programming button. Pesez et relâchez le bouton de programmation.	The RED LED will flash once (1x). La DEL ROUGE clignote une (1x) fois.	Using a jumper wire, apply power (12v) to the vehicles ignition. À l'aide d'un fil (jumper) appliquez 12v sur l'ignition du véhicule.	The RED LED will flash ten (10x) times. La DEL ROUGE clignotera dix (10x) fois.
				If the LED is solid RED disconnect the 4-pin connector (Data-Link) and go back to step 1. Si le DEL est Rouge solide débranchez le connecteur 4-pins (Data-Link) et retournez à l'étape 1.
				Remove the jumper. The module is now programmed. Retirez le fil (jumper). Le module est programmé.



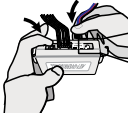
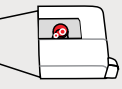

PROGRAM. 3

TOYOTA / LEXUS

1

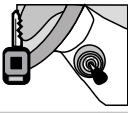
 <p>Press and hold the programming button: Appuyez et maintenez enfoncé le bouton de programmation:</p>	 <p>Insert connector 2. (6-pin) Insérez le connecteur 2 (6-pins).</p>	 <p>Insert connector 3. (4-pin - if required) Insérez le connecteur 3 (4-pins - si requis).</p>	 <p>Insert the 4-pin (Data-Link) connector. Insérez le connecteur 4-pins (Data-Link).</p>	 <p><i>The RED LED will turn ON.</i> <i>La DEL ROUGE s'allumera.</i></p>	 <p>Release the programming button. Relâchez le bouton de programmation.</p>
---	--	--	--	---	---



2

 <p>Vehicle with 80-bit G-key: Véhicule avec 80-bits G-Key: Start the vehicle with the key. Démarrez le véhicule avec la clé.</p>	 <p>Other vehicle: Autre véhicule: Insert one functional key in to the ignition barrel. <i>Do not turn the key.</i> Insérez la clé fonctionnelle dans le barillet. <i>Ne tournez pas la clé.</i></p>	 <p><i>Flash X10</i></p> <p><i>The RED LED will flash ten (10x) times.</i> <i>La DEL ROUGE clignotera dix (10x) fois.</i></p>	 <p>If the LED is solid RED disconnect the 4-pin connector (Data-Link) and go back to step 1. Si le DEL est Rouge solide débranchez le connecteur 4-pins (Data-Link) et retournez à l'étape 1.</p>	 <p><i>The module is now programmed.</i> <i>Le module est programmé.</i></p>
---	---	--	---	---





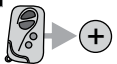



PROGRAM. 4

TOYOTA / LEXUS (SMART KEY)

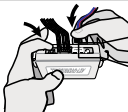
1

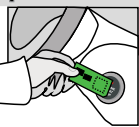
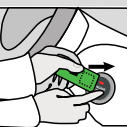
 <p>Remove the battery from 1 OEM remote. Retirez la pile d'une des télécommandes d'origine.</p>	<p>2</p>  <p>Keep the other OEM remotes away from the vehicle. Minimum 3 meters (10 feet). Eloignez les autres télécommandes d'origine à plus de 3 mètres (10 pieds) du véhicule.</p>
--	---

3

 <p>Press and hold the programming button: Appuyez et maintenez enfoncé le bouton de programmation:</p>	 <p>Insert connector 2. (6-pin) Insérez le connecteur 2 (6-pins).</p>	 <p>Insert connector 3. (4-pin - if required) Insérez le connecteur 3 (4-pins - si requis).</p>	 <p>Insert the 4-pin (Data-Link) connector. Insérez le connecteur 4-pins (Data-Link).</p>	 <p><i>The RED LED will turn ON.</i> <i>La DEL ROUGE s'allumera.</i></p>	 <p>Release the programming button. Relâchez le bouton de programmation.</p>
 <p>Hold the OEM remote (without battery) against the START/STOP button. Appuyez la télécommande d'origine (sans batterie) devant le bouton ENGINE START/STOP comme illustrée.</p>	 <p>Press and hold the Start/Stop button. Pesez et maintenez enfoncé le bouton Start/Stop.</p>	 <p><i>Flash X10</i></p> <p><i>The RED LED will flash ten (10x) times.</i> <i>La DEL ROUGE clignotera dix (10x) fois.</i></p>	 <p>If the LED is solid RED disconnect the 4-pin connector (Data-Link) and go back to step 1. Si le DEL est Rouge solide débranchez le connecteur 4-pins (Data-Link) et retournez à l'étape 1.</p>	 <p><i>The module is now programmed.</i> <i>Le module est programmé.</i></p>	 <p>Release the Start/Stop button. Make all the connection at the KEY-OVERRIDE-ALL yellow wire if required. Reinstall the battery in the OEM remote. Relâchez le bouton Start/Stop. Effectuez les branchements au fil Jaune si requis du KEY-OVERRIDE-ALL. Remettez la pile dans la télécommande d'origine.</p>

PROGRAM. 5 ACURA / HONDA / CHEVROLET / HYUNDAI / KIA / PONTIAC / SUZUKI / NISSAN / INFINITI / MAZDA

1



Press and hold the programming button:
Appuyez et maintenez enfoncé le bouton de programmation:



Insert connector 2. (6-pin)
Insérez le connecteur 2 (6-pins).



Insert connector 3. (4-pin - if required)
Insérez le connecteur 3 (4-pins - si requis).

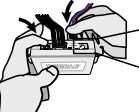

Insert the 4-pin (Data-Link) connector.
Insérez le connecteur 4-pins (Data-Link).



The RED LED will turn ON.
La DEL ROUGE s'allumera.



Release the programming button.
Relâchez le bouton de programmation.

2

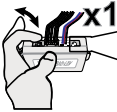







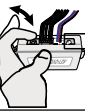

Press and Release the programming button.
Appuyez et relâchez le bouton de programmation.

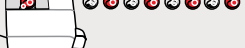

The RED LED will turn OFF and turn back ON.
La DEL ROUGE s'éteint et se rallume.

3

A	ACURA HONDA	 x1		x1
B	CHEVROLET HYUNDAI KIA PONTIAC SUZUKI	 x2		x2
C	NISSAN INFINITI	 x3		x3
D	MAZDA MIATA MPV	 x4		x4
E	CHEVROLET PONTIAC OLDSMOBILE	 x5		x5

4

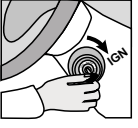

Turn the Ignition to the ON/RUN position.
Miata & MPV: **Start** the vehicle.
Tournez la clef en position **ignition (ON)**.
MIATA & MPV : **Démarrez** le véhicule.



Flash **x10**

The RED LED will flash ten (10x) times.
La DEL ROUGE clignotera dix (10x) fois.



If the LED is solid RED disconnect the 4-pin connector (Data-Link) and go back to step 1.
Si le DEL est Rouge solide débranchez le connecteur 4-pins (Data-Link) et retournez à l'étape 1.



The module is now programmed.
Le module est programmé.

Use the remote of the remote starter or security system to test all of the supported features to ensure proper programming.
Testez toutes les fonctions supportées sur le véhicule avec la télécommande du démarreur à distance ou du système de sécurité.

PROGRAM. 6 FORD / MAZDA SCAN TOOL REQUIRED | SCAN TOOL REQUIS

Vehicle equipped with SMART KEY
Véhicule équipé d'une clé INTELLIGENTE



Remove all keys from key remote cards.

Retirez les 2 clés des télécommandes. (cartes).



Keep all cards at least 3 meters (10 feet) away from the vehicle to proceed.

Éloignez les télécommandes du véhicule (10 pieds / 3 mètres minimum) pour procéder à la programmation.

1 Or | Ou



Insert the key in to the ignition barrel.

Insérez la clé dans le barillet d'ignition.



Press the Push to start button to turn ON the ignition.

Appuyez sur le bouton démarrage pour mettre l'ignition en position ON.



Wait 1 minute.

Attendez (1) une minute.

1



Press and hold the programming button:
Appuyez et maintenez enfoncé le bouton de programmation:



Insert connector 2. (6-pin)
Insérez le connecteur 2 (6-pins).



Insert connector 3. (4-pin - if required)
Insérez le connecteur 3 (3-pins - si requis).



Insert the 4-pin (Data-Link) connector.
Insérez le connecteur 4-pins (Data-Link).



The **RED LED** will turn ON.
La **DEL ROUGE** s'allumera.

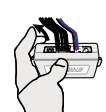

Release the programming button.
Relâchez le bouton de programmation.

A DEALER SCAN TOOL IS REQUIRED. The following steps should be performed by a qualified technician:
Le SCAN TOOL DU CONCESSIONNAIRE EST REQUIS. La procédure suivante doit être effectuée par un technicien qualifié.

2

Connect the SCAN TOOL .
Navigate the SCAN TOOL menu to **program** a new ignition key to the vehicle.

Branchez le SCAN TOOL. **Suivre** les indications du SCAN TOOL pour **programmer** une nouvelle clé d'ignition.

When the SCAN TOOL is ready to program a new key:

Lorsque le SCAN TOOL du concessionnaire est prêt à programmer la nouvelle clé:



Remove the key from the ignition barrel.

Retirez la clé du barillet d'ignition **sans éteindre** l'ignition.



Press and release the programming button on the module.
Appuyez et relâchez le bouton de programmation du module.

Complete the programming on the dealer scan tool.

Exécutez la fonction de programmation de la nouvelle clé indiquée sur le Scan Tool.

Programming was successful if the dealer scan tool indicates that a new ignition key has been programmed to the vehicle.

La programmation réussie lorsque le scan tool indique qu'une nouvelle clé d'ignition est programmée sur le véhicule.



The **RED LED** will flash ten (10x) times.
La **DEL ROUGE** clignotera dix (10x) fois.



If the LED is solid RED disconnect the 4-pin connector (Data-Link) and go back to step 1.
Si le DEL est Rouge solide débranchez le connecteur 4-pins (Data-Link) et retournez à l'étape 1.



The module is now programmed.
Le module est programmé.



FORTIN®

KEY-OVERRIDE-ALL

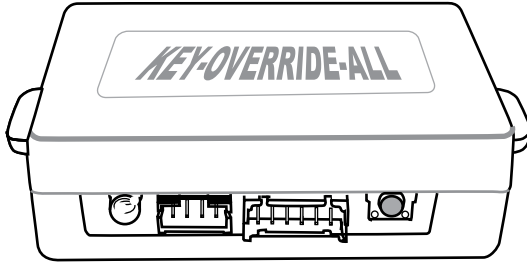

TECHNICAL SUPPORT / INFORMATION

Neither the manufacturer or distributor of this module is responsible for damages of any kind either indirectly or directly caused by this module, except for the replacement of this module in case of manufacturing defects. This module must be installed by a qualified technician.

This instruction guide may change without notice. Visit www.fortinbypass.com to obtain the latest version.

INFORMATIONS / SUPPORT TECHNIQUE

Ni le fabricant, ni le distributeur ne se considèrent responsables des dommages causés ou ayant pu être causés, indirectement ou directement, par ce module, excepté le remplacement de ce module en cas de défectuosité de fabrication. Ce module doit être installé par un technicien qualifié.

Ce guide d'instruction peut faire l'objet de changement sans préavis. Consultez le www.fortinbypass.com pour voir la plus récente version.

www.fortinbypass.com

WEB UPDATE | MISE À JOUR INTERNET



TECHNICAL SUPPORT

Tél: 514-255-HELP (4357)

1-877-336-7797



INSTALLATION GUIDE

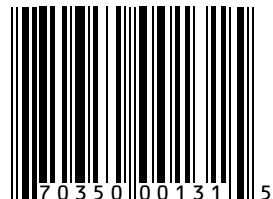

7 70350 00131 5